



CR4150 True RMS AC Current Transducer

SINGLE ELEMENT / DIN RAIL / PANEL MOUNT

The **CR4100** Series true RMS Current Transducers and Transmitters are designed for applications where AC current waveforms are not purely sinusoidal. More precise and accurate than other transducers, these devices are ideal in chopped wave and phase fired control systems.



CR4110 CR4120
One Element - .79" Window
0.5 to 150 Aac Range



CR4150 CR4160
Two Element - .26" Window
0.5 to 30 Aac Range



CR4170 CR4180
Three Element .26" window
0.5 to 30 Aac Range

Regulatory Agencies

Approved to UL3111-1, First Edition, Amendment 2
Approved to CAN/CSA-C22.2, No. 1010.1-92
Meets requirement of IEC 61010-1 and BS EN 61010-1

Applications

- Phase fired controlled heaters
- Quickly varying motor loads
- Chopped wave form drivers
- Harmonic currents

Features

- 35mm DIN Rail or Panel Mount
- Available with 0 - 5 Vdc or 4 - 20 mA DC outputs
- 24 Vdc powered
- Use with external current transformers
- Highest precision available
- Connection diagram printed on case

- Pricing: pricing/4100.html
- Application Sheets: pdf/ancr4310.pdf, pdf/ancr4310-2.pdf, pdf/ancr4320.pdf

See page 34 for typical applications

Part Numbers

- CR4110** - Single element with 0 - 5 Vdc output
- CR4120** - Single element with 4 - 20 mA DC output
- CR4150** - Two element with 0 - 5 Vdc output *
- CR4160** - Two element with 4 to 20 mA DC output *
- CR4170** - Three element with 0 - 5 Vdc output *
- CR4180** - Three element with 4 - 20 mA DC output *

* Two and three element transducers are available only in ranges of 0.5 to 30 Aac

Add suffix for input range

.5	-	0-.5 Aac *	40	-	0-40 Aac
5	-	0- 5 Aac *	50	-	0-50 Aac
10	-	0-10 Aac *	75	-	0-75 Aac
15	-	0-15 Aac *	100	-	0-100 Aac
20	-	0-20 Aac *	150	-	0-150 Aac
25	-	0-25 Aac *			
30	-	0-30 Aac *			

Other Ranges Available

Specifications

Basic Accuracy:.....	0.5%	Frequency Range:.....	20 Hz - 5 KHz
Calibration:.....	True RMS Sensing	MTBF:.....	Greater than 100 K hours
Thermal Drift:.....	500 PPM/°C	Cleaning:.....	Water-dampened cloth
Operating Temperature:.....	0°C to +60°C	Supply Voltage:.....	24 Vdc ±10%
Installation Category:.....	CAT II	Output Load:.....	4-20 mA dc - 0 to 300 Ω
Pollution Degree:.....	2		0-5 Vdc - 2K Ω or Greater
Insulation Voltage:.....	2500 Vdc	Response Time:.....	250 ms max. 0-90% FS
Altitude:.....	2000	Relative Humidity:.....	80% for temperatures up to 31°C and decreasing linearly to 50% at 40°C

Connection Drawings

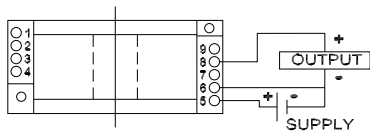

CR4110 One Element 0 - 5 Vdc Output

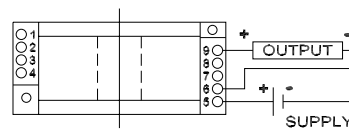

CR4120 One Element 4 - 20 mA DC Output

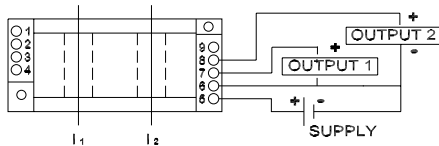

CR4150 Two Element 0 - 5 Vdc Output

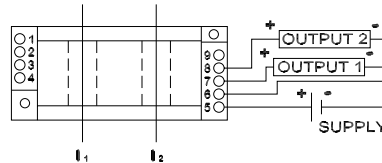

CR4160 Two Element 4 - 20 mA DC Output

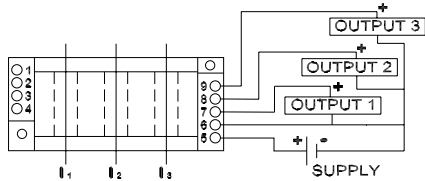

CR4170 Three Element 0 - 5 Vdc Output

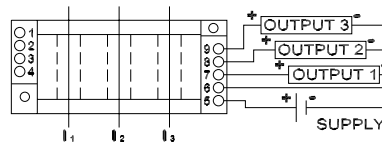

CR4180 Three Element 4 - 20 mA DC Output

Note: The building installation must have a switch or circuit-breaker that is in close proximity and within easy reach of the operator. The switch or circuit breaker shall be marked as the disconnecting device for the equipment.

Outline Drawing

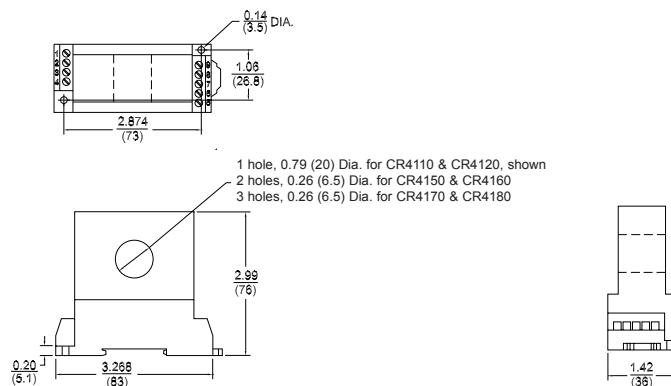

inch (mm)